

Hazardous Area LED Lighting
HPLN LED lighting

CROUSE-HINDS
SERIES

HPLN LED lighting for hazardous areas



EATON

Powering Business Worldwide



Safe. Reliable. Efficient.

Featuring the industry's broadest range of LED luminaires for harsh and hazardous environments, Eaton's Crouse-Hinds can deliver a lighting solution that performs reliably in even the worst operating conditions. All the while reducing your energy, maintenance and manpower costs.

Why LED?

Useful life

Rated life of 60,000 hours of maintenance-free and safe operation

Energy efficiency

LED average energy consumption is 50% less than HID and 85% less than incandescent

Start/restart time

Instant illumination compared to 10 minute restrike time for HID

Light quality

Higher color rendering and color temperature compared to fluorescent

Environmental benefits

Mercury-free LED eliminates disposal costs and lower energy consumption for a smaller carbon footprint

Why Crouse-Hinds?

Industry-best reliability

Built to withstand extreme temperatures, vibration, water and dust

Thermal management

Effective heat sinking ensures longer life

Quality of light

Custom optics designed to maximize light distribution and intensity

Retrofit compatibility

LED fixtures are compatible with Crouse-Hinds' HID installed base

HPLN LED features

Designed for Zone 1 hazardous areas. HPLN LED luminaires are engineered to provide high quality, maintenance-free illumination in the most demanding hazardous rated environments. The HPLN LED is available in 8 models ranging from 3,000 to 25,000 lumens, providing a lighting solution for areas with mounting heights from 2.5 meters to 12 meters.

A

AC/DC universal input and built-in surge protection device (SPD)

- 4kV protection as standard, but option up to 10kV surge protection for offshore applications

B

Rugged design

- Copper-free aluminum housing, tempered and impact resistant glass globe
- Outstanding corrosion proof capability (C5M-IEC, UL1598A-UL) and anti vibration design
- Lightweight but durable Zone 1 IIC fixture

C

Robust heat sink

- Innovative heat sink facilitates air flow, ensuring long life in extreme environments

D

Mounting style

- IEC (trunnion indirect cable system) and NEC (direct conduit system) mounting style available
- Stanchion, pendant, ceiling, wall and trunnion mounting options for installation flexibility



E

Superior optical performance

- 5000K & 4000K models available; consult factory for additional options (5700K, 3000K)
- Narrow (25°) / medium (60°) / wide (120°) beam optics available to distribute the light where it is needed the most
- Efficiency up to 130 lm/W to save more energy

Frosted lens option

- Reduces dangerous and unwanted glare on critical applications

Why choose HPLN LED lighting?

Multiple versions of the HPLN LED are available from 3,000 to 25,000 lumens, providing a single solution for a wide range of lighting applications.



Safe, reliable and efficient. HPLN LED luminaires are engineered to deliver high lumen output and maintenance-free long life in the toughest conditions.

HPLN 7L vs. 175 watt HID

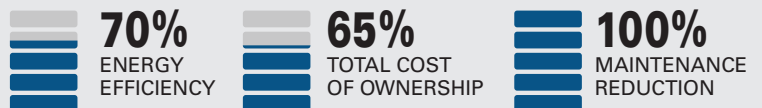

Assumptions: Calculations based on overall life of the LED system. Energy cost of €0.09 per kilowatt; 24 hour per day operation; labor rate of €75 each for 2 workers; average time for fixture maintenance of 2 hours.

Features & specifications

Rugged solutions for challenging environments

HPLN LED luminaires are used for general lighting in hazardous areas where flammable or explosive vapors or gases are present.

The HPLN features a compact, high-efficacy design with custom optics to ensure maximum light distribution and intensity. It is available with a variety of mounting options for installation flexibility.

Model	Nominal* lumens	Wattage	HID Equivalent
HPLN-3L	3483	26	70W-100W
HPLN-5L	5323	40	100W-150W
HPLN-7L	6684	50	150W-175W
HPLN-9L	9574	70	175W-250W
HPLN-11L	11466	85	250W-450W
HPLN-15L	14783	110	400W
HPLN-21L	21128	163	600W
HPLN-25L	24229	190	600W-1000W

*tolerance $\pm 10\%$, nominal lumen data for 5000K, clear glass, wide beam angle

Application:

- Locations requiring continuous and consistent light levels in extreme ambient temperatures
- Areas requiring frequent on-and-off of lights
- Where flammable vapors, gases, ignitable dusts, fibers or flyings are present; indoors or outdoors
- Where extremely corrosive, wet, dusty, hot and/or cold conditions exist
- Marine, wet locations and hose-down environments
- For areas with mounting heights up to 12 meters in manufacturing plants, heavy industrial, chemical, petrochemical or pharmaceutical facilities, platforms, loading docks and tunnels etc.

HPLN LED benefits:

- Instant illumination and strike
- Cold temperature operation/no warm up requirement
- Multiple mounting options provide installation flexibility and ease
- Contains no mercury or other hazardous substance
- Shock-and vibration-resistant



Certifications and compliances:

Marking accd.to 2014/34/EU:

- II 2 G Ex db eb mb op is IIC T4 Gb
- II 2 D Ex tb op is IICT95°C Db

Certificate No.

- Presafe 20 ATEX 39851X

Permissible ambient temperature

- -40°C up to +55°C

Degree of protection accd. to EN60529

- IP66

LED system:

- 5000K (CRI70) & 4000K (CRI80) as standard options. Consult factory for 3000K, 5700K
- Narrow (25°) / medium (60°) / wide (120°) beam optics available

Standard materials:

- Body and mounting modules – copper-free aluminum with C5M coating
- Lens-tempered and impact resistant glass globe
- Gaskets – silicone
- Guard – stainless steel

Features & specifications

Electrical rating:

	3L	5L	7L	9L	11L	15L	21L	25L
Voltage range VAC	100-240	100-240	100-240	100-240	100-240	100-240	100-240	100-240
Input power (watts)	26	40	50	70	85	110	163	190
Frequency	50/60Hz	50/60Hz	50/60Hz	50/60Hz	50/60Hz	50/60Hz	50/60Hz	50/60Hz
Inrush current	12A for 1ms	12A for 1ms	12A for 1ms	12.5A for 1ms	12.5A for 1ms	24A for 1ms	25A for 1ms	25A for 1ms
Input amps at 100-240 VAC	0.8A max@100VAC 0.35A max@240VAC			1.3A max@100VAC 0.6A max@240VAC		1.6A max@100VAC 0.7A max@240VAC		2.6A max@100VAC 1.2A max@240VAC
Power factor	≥0.95	≥0.95	≥0.95	≥0.95	≥0.95	≥0.95	≥0.95	≥0.95
Voltage range VDC	127-250	127-250	127-250	127-250	127-250	127-250	127-250	127-250
THD	<10%	<10%	<10%	<10%	<10%	<10%	<10%	<10%

Weight:

Model	Appr. kg
3L-11L	11kg
15L	14kg
21/25L	15kg

Polar Curves

3L-25L wide 120°

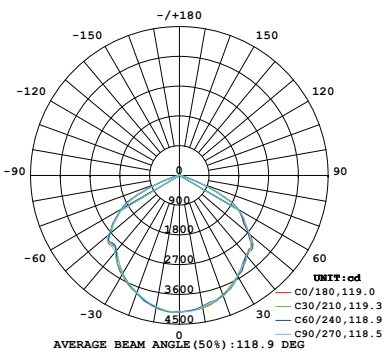

3L-25L medium 60°

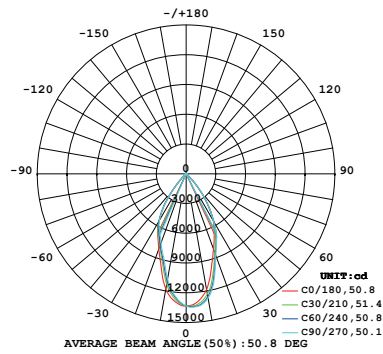

3L-25L narrow 25°

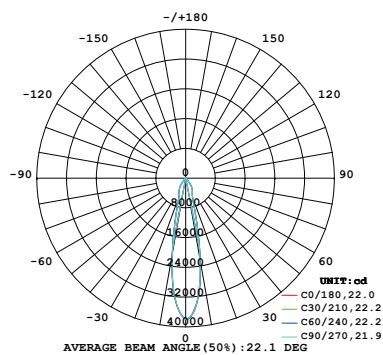

Ordering information

Part number example

HPLN-9L-C2-25C-W

HPLN LED fixture, 9574 lumens, 5000K (CRI 70), 25mm ceiling mount, 120° wide light beam, clear lens, without guard, 4kV surge protection

HPLN

-9L*

Total lumens

3L	3483
5L	5323
7L	6684
9L	9574
11L	11466
15L	14783
21L	21128
25L	24229

-C2

Color Temp.

C1	4000K**
C2	5000K**

-25C

Mounting type

Blank ◊	no cover
25J*** ◊	1-1/2" Stanchion, 25° Angled
25P*** ◊	1-1/2" Stanchion, Straight
20C ◊	20mm Ceiling
25C	25mm Ceiling
20TW ◊	20mm Wall
25TW	25mm Wall

-W

Beam angle

W	Wide (120°)
M ◊	Medium (60°)
N ◊	Narrow (25°)

-F

Glass

Blank	Clear Glass
F ◊	Frosted Glass

-G

Guard

Blank	without guard
G ◊	with guard

-S

Surge

Blank	4kV
S ◊	10kV

* Tolerance ±10%, nominal lumen data for 5000K, clear glass, wide beam angle

** Please contact Eaton's Crouse-Hinds sales representative for additional color temperatures

*** For 1-1/2" / M20 stanchion mounts, change "25" to "20" (ex. 20J, 20P)

◊ Available upon request. Please consult factory

Typical ordering codes for HPLN LED luminaire

	Lumen output	Color temp	Mounting type	Beam pattern	Ordering Code
HPLN	-3L (3483)	-C1 (4000K)	-25C (25mm ceiling)	-W (120°)	CCL1754651C40E
HPLN	-5L (5323)	-C1 (4000K)	-25C (25mm ceiling)	-W (120°)	CCL1754779C40E
HPLN	-7L (6684)	-C1 (4000K)	-25C (25mm ceiling)	-W (120°)	CCL1754907C40E
HPLN	-9L (9574)	-C1 (4000K)	-25C (25mm ceiling)	-W (120°)	CCL1755035C40E
HPLN	-11L (11466)	-C1 (4000K)	-25C (25mm ceiling)	-W (120°)	CCL1755163C40E
HPLN	-15L (14783)	-C1 (4000K)	-25C (25mm ceiling)	-W (120°)	CCL1755291C40E
HPLN	-21L (21128)	-C1 (4000K)	-25C (25mm ceiling)	-W (120°)	CCL1755419C40E
HPLN	-25L (24229)	-C1 (4000K)	-25C (25mm ceiling)	-W (120°)	CCL1755547C40E
HPLN	-3L (3483)	-C1 (4000K)	-25TW (25mm wall)	-W (120°)	CCL1766939C40E
HPLN	-5L (5323)	-C1 (4000K)	-25TW (25mm wall)	-W (120°)	CCL1767067C40E
HPLN	-7L (6684)	-C1 (4000K)	-25TW (25mm wall)	-W (120°)	CCL1767195C40E
HPLN	-9L (9574)	-C1 (4000K)	-25TW (25mm wall)	-W (120°)	CCL1767323C40E
HPLN	-11L (11466)	-C1 (4000K)	-25TW (25mm wall)	-W (120°)	CCL1767451C40E
HPLN	-15L (14783)	-C1 (4000K)	-25TW (25mm wall)	-W (120°)	CCL1767579C40E
HPLN	-21L (21128)	-C1 (4000K)	-25TW (25mm wall)	-W (120°)	CCL1767707C40E
HPLN	-25L (24229)	-C1 (4000K)	-25TW (25mm wall)	-W (120°)	CCL1767835C40E

Safety cable

Mounting type	Config	Part no
Ceiling with U bracket	3L-25L	CHR6196
		CCL1625591
Other mounting	3L-11L	CHR7005
	15L-25L	CCL1622490

Trunnion mounting bracket (for ceiling mounting only)

Part no	Config
CHLAS2182-06	Trunnion bracket for 3L-11L
CHLAS2183-06	Trunnion bracket for 15L
CHLAS2184-06	Trunnion bracket for 21L-25L



Trunnion for floodlight applications

Mounting options and dimensions

3- 11L

Stanchion – straight

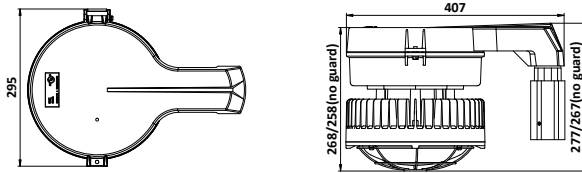

Stanchion – 25° angled

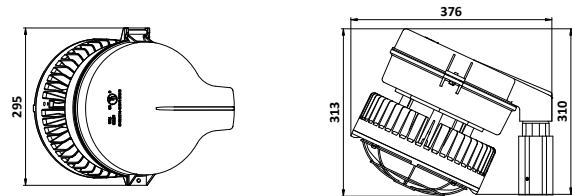

Ceiling

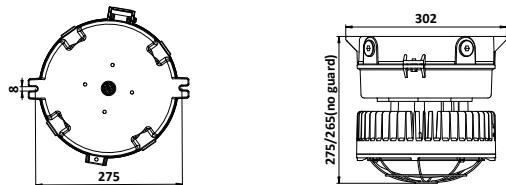

Wall

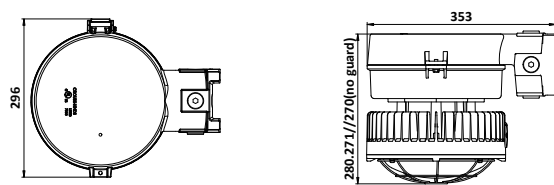

Trunnion

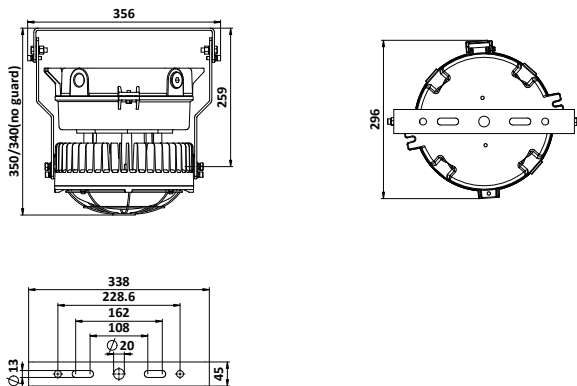

Mounting module

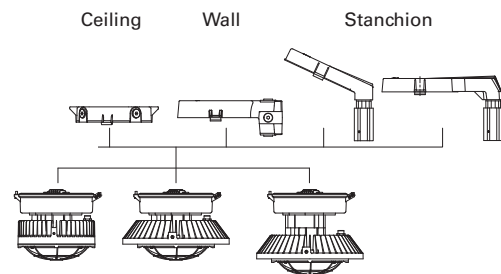

Mounting options and dimensions 15L

Stanchion – straight

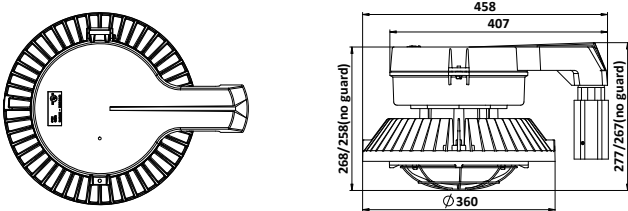

Stanchion – 25° angled

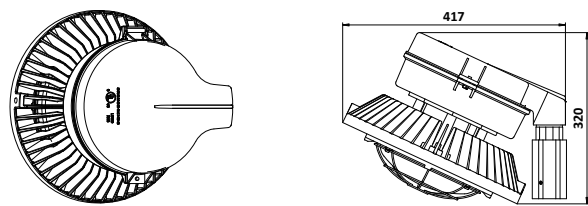

Ceiling

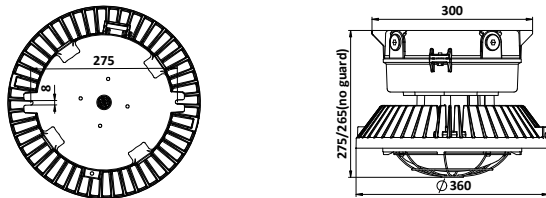

Wall

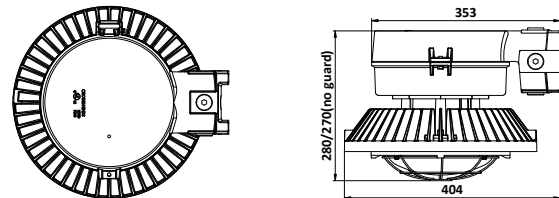

Trunnion

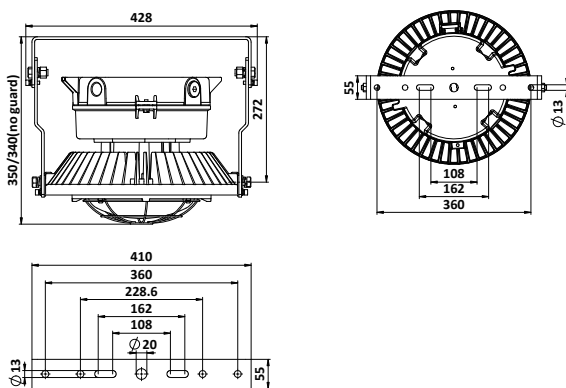

Mounting modules

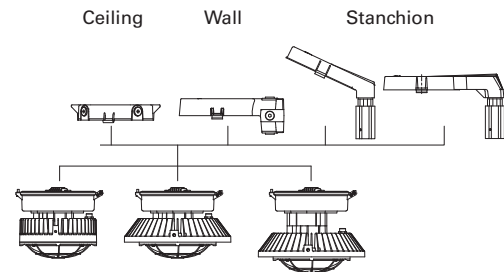

Mounting options and dimensions 21L/25L

Stanchion – straight

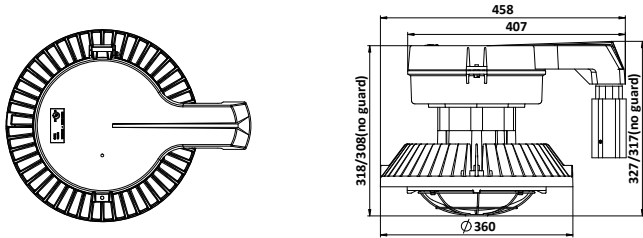

Stanchion – 25° angled

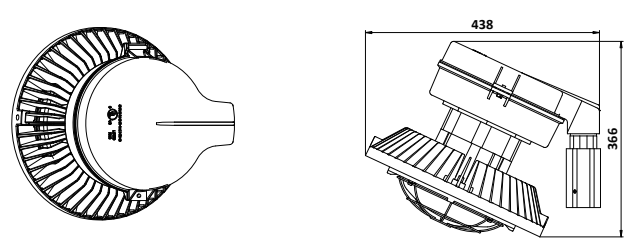

Ceiling

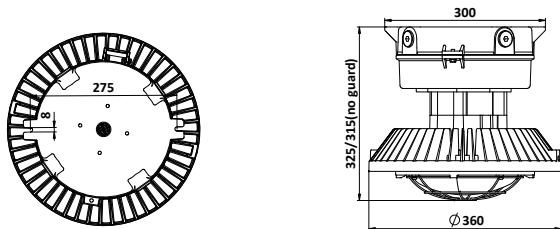

Wall

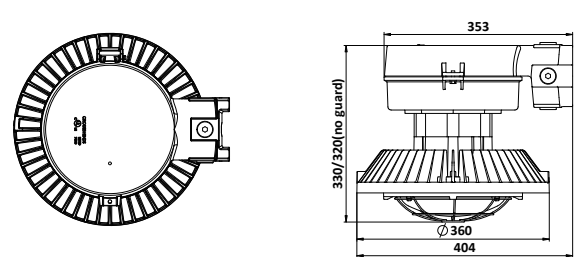

Trunnion

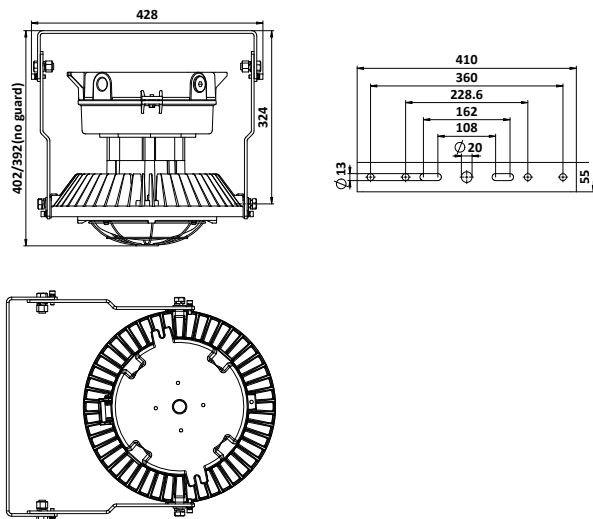

Mounting modules

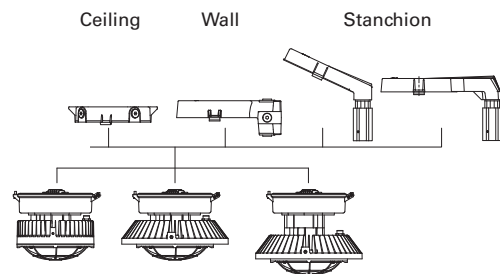

The safety you rely on.

See our complete offering of hazardous and industrial products at www.eaton.com

North America

1201 Wolf Street
Syracuse, NY 13208

Phone: (866) 764-5454

FAX: (315) 477-5179

FAX Orders Only:

(866) 653-0640

CrouseCustomerCTR@Eaton.com

Germany

Neuer Weg – Nord 49
D-69412 Eberbach

Phone +49 (0) 6271/806-500

Fax +49 (0) 6271/806-476

E-mail info-ex@eaton.com

Internet www.crouse-hinds.de

China

No.955 Shengli Road,
Pudong District, Shanghai 201201
China

86-21-2899-3600

FAX: 86-21-2899-4055

Echsales@eaton.com

For more information:

If further assistance is required, please contact an authorized Eaton Distributor, Sales Office, or Customer Service Department.

Australia

Phone +61-2-8787-2777

Fax +61-2-9609-2342

crousehindsanz@eaton.com

Great Britain

Phone +44-247-630-89 30

Fax +44-247-630-10 27

sales5@eaton.com

India

Phone +91-124-4683888

Fax +91-124-4683899

cchindia@eaton.com

Canada

Toll Free +1-800-265-0502

Fax +1-800-263-9504

Fax orders only:

+1-866-653-0645

Korea

Phone +82-2-3484-6783

Fax +82-2-3484-6778

CCHK-sales@cooperindustries.com

Mexico/Latin America/ Caribbean

Phone +52-555-804-4000

Fax +52-555-804-4020

mxmercadotecnia@cooperindustries.com

Spain

Phone +34-9-37362710

Fax +34-9-37835055

sales.CCH.es@cooperindustries.com

Middle East (Dubai)

Phone +971-4-427-2522 / 2500

Fax +971-4-429-8521

CHMEsales@Eaton.com

The Netherlands

Phone +31-10-2452145

Fax +31-10-2452121

CHRD_mail@Eaton.com

Norway

Phone +47-32-244600

Fax +47-32-244646

CHLlooffice@eaton.com

Singapore:

Phone +65-6645-9888

Fax +65-6297-4819

CHSI-Sales@Eaton.com

Turkey

Phone +90-216-464-20-20

Fax +90-216-464-20-10

infoEGTurkey@eaton.com

Russia

Phone +7-495 510-24-27

Fax +7-495 510-24-28

info@cooper.ru.com

www.cooper-russia.ru

Eaton

1000 Eaton Boulevard
Cleveland, OH 44122
United States
Eaton.com

© 2022 Eaton Corporation
All Rights Reserved
Printed in Germany
Publication No. BR403008EN
July 2022

Eaton is a registered trademark.

All other trademarks are property of their respective owners.